

eldoLED
mastering light

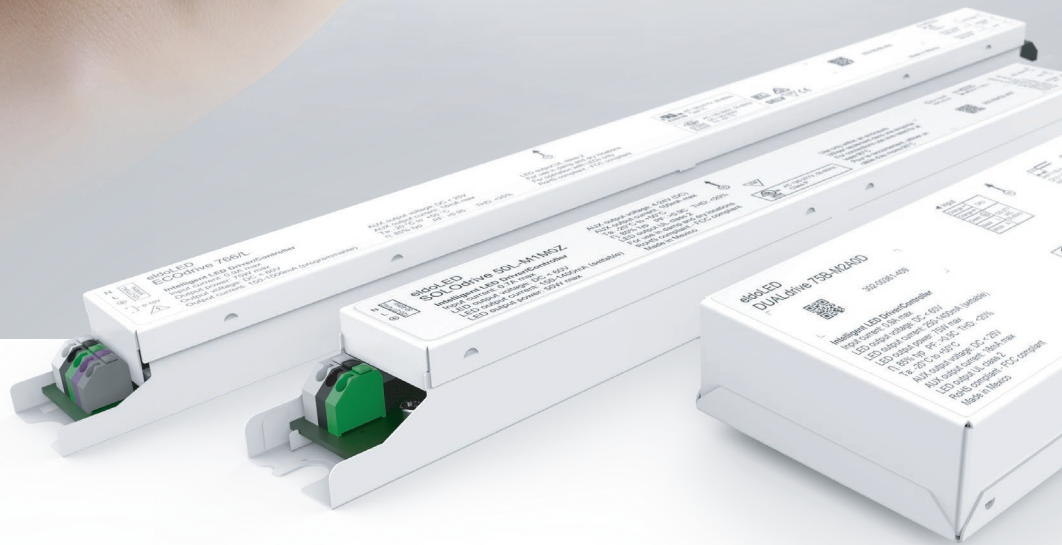

LED Driver Selection Guide

Global Edition

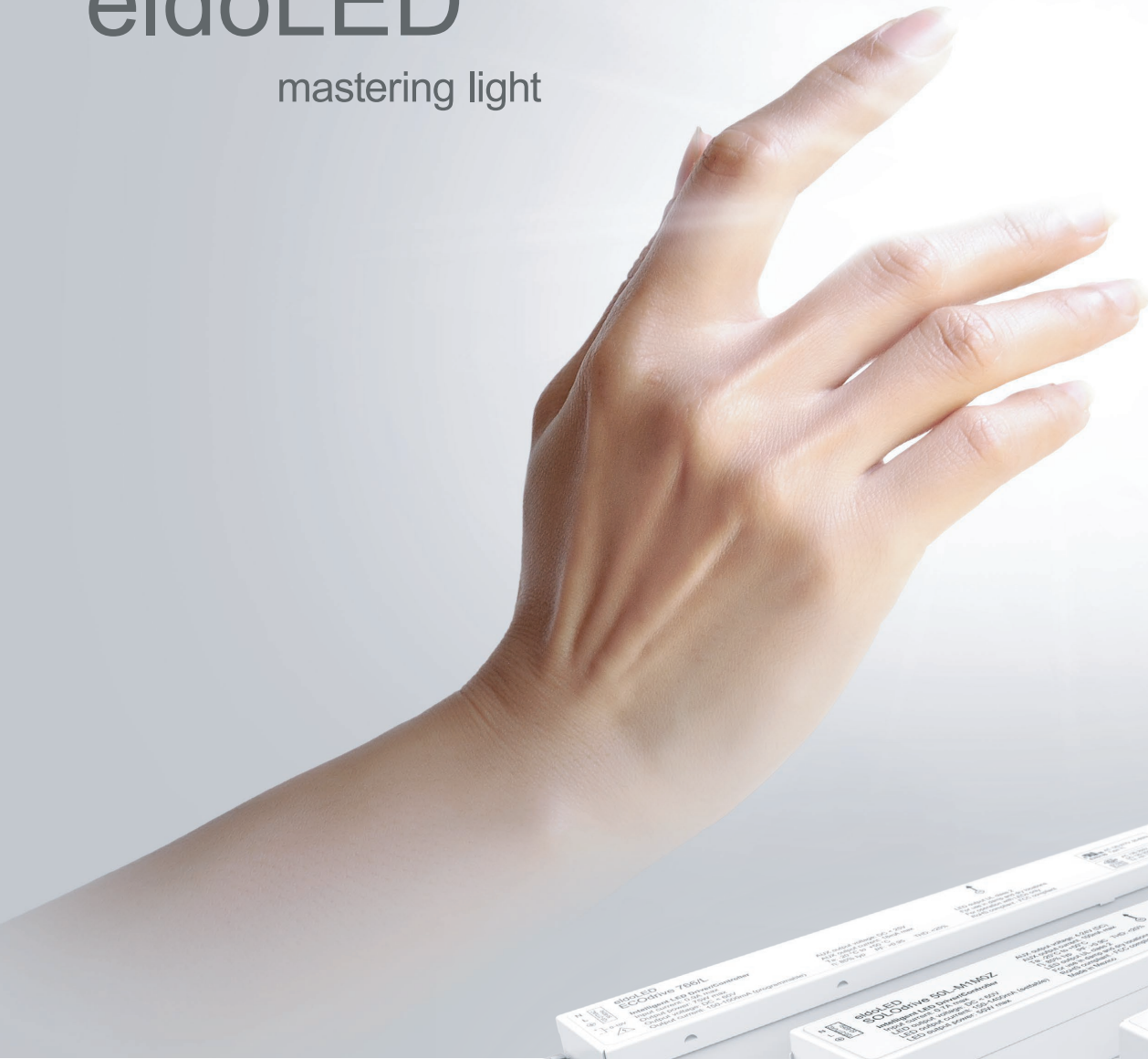

Photo: Peter Baas Photography, courtesy of MoreSenz

Introduction

By setting standards for dimming, flicker and enabling quality light, eldoLED drivers play an essential role in the transformation of lighting.

Our aim is to reduce complexity, ensure reliability, and facilitate beautifully lit spaces. We achieve this by innovating, in order to create the future of human centric lighting and spectrum management.

eldoLED's digital driver technology makes it possible to seamlessly integrate components —from source to lens or sensor— across a room, building or site. Regardless of protocol or control system.

Our drivers, featuring two-way communications, are a reliable constant in the design of any solution and key to creating attractive, healthy lighting.

This selection guide presents an overview of our product portfolio. You'll find descriptions of each driver family and a matrix to help find the right eldoLED driver for your application.

ECOdrive

Value Delivered

Premium performance for general lighting. Smooth and flicker-safe dimming down to 1% with programmable current setting.

- Natural Dimming – Dim to 1%
- Constant Current
- DALI-2 or 0-10V controls
- LEDcode for in-luminaire intelligence
- Power levels from 10W to 100W
- For indoor applications

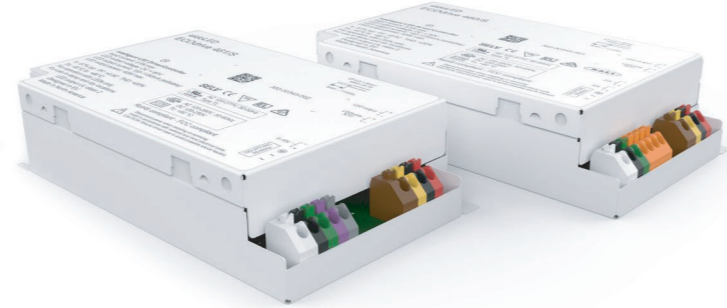

SOLOdrive

LED Dimming Made Beautiful

The smoothest dimming all the way to dark. With any controller, in any application. What's more, LightShape allows you to tailor the dimming curve to perfectly match your lighting application.

- Natural Dimming – Dim to Dark (0.1%)
- Constant Current
- DALI-2, 0-10V or DMX controls, single channel
- LightShape for Dim to Warm applications
- LEDcode for in-luminaire intelligence
- Power levels from 10W to 100W
- For indoor applications



DUALdrive

Every Shade Of White

Designed for dynamic and Tunable White LED lighting. DUALdrive excels in configurability, deep dimming, and two-way digital control.

- Natural Dimming – Dim to Dark (0.1%)
- Constant Current
- DALI-2 or 0-10V controls, dual channel
- LightShape for Tunable White applications
- LEDcode for in-luminaire intelligence
- Power levels from 20W to 120W
- For indoor applications



POWERdrive

Beyond Color

Achieve more than the right color and the smoothest fade. POWERdrive is DMX and DALI compatible. In addition, it allows you to create your color or dynamic show without an external controller. POWERdrive's dynamic response allows you to fine-tune your application like no other driver!

- Natural Dimming – Dim to Dark (0.1%)
- Constant Current
- DMX / RDM or DALI controls
- RGB(W) control, in line with 3 and 4 channel configurations
- Application-specific dynamic response
- Power levels from 45W to 600W
- For indoor applications



LINEARdrive

Infinite Color Control

All the color you will ever need for low-voltage LED applications. LINEARdrive products cover applications from single color for accent and cove lighting right up to RGBW for full-color entertainment product solutions. All industry control protocols are covered: DALI, DMX/ RDM and 0-10V—you'll not run out of control options with LINEARdrive!

- Natural Dimming – Dim to Dark (0.1%)
- Constant Voltage
- DALI-2, DMX / RDM or 0-10V controls
- Designed for 12V or 24V LED tape lighting
- Application-specific dynamic response
- Power levels up to 720W
- For indoor applications
- LightShape for Dim to Warm or Tunable White applications



48V DC LED Track Driver

Performance Without Compromise

Made for 48V DC track lighting - The 48V DC 32W is the only programmable track driver on the market that meets flicker performance industry requirements. High quality deep-dimming and Tunable White capabilities perfect for any retail, indoor or hospitality space.

- Natural Dimming – Dim to Dark (0.1%)
- Industry Compliance – UL Recognition, EMI Compliance, ENEC & CE, Flicker Performance
- DALI-2 controls
- Dim to Warm and Tunable White capabilities
- Fully programmable output current range (150-1050mA)
- Batch pre-assembling capabilities
- Compatible with the Stucchi MULTISYSTEM and MULTISYSTEM EVO track system
- Interoperable with Helvar, Tridonic, Casambi, Zencontrol, Crestron, Lutron, Encelium network lighting control systems

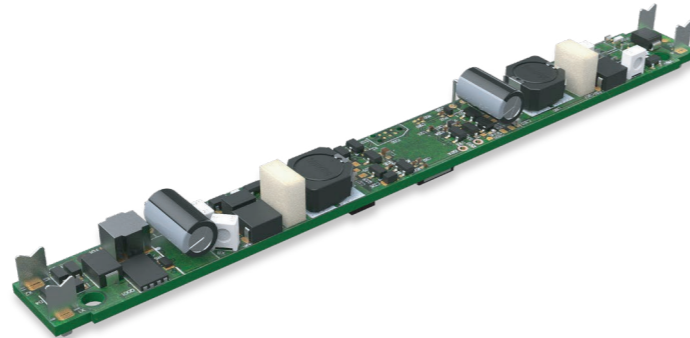

Product Selector

On the next pages, you will find an overview of eldoLED's driver portfolio with a variety of options.

You can easily select the most suitable product based on the most critical elements of an LED driver:

- Driver Family
- Output Power
- Controls Type
- Constant Current vs. Constant Voltage
- Form Factor

LEDcode2

LEDcode2

The ECOdrive, SOLOdrive and DUALdrive families support LEDcode2. Several products exclusively support LEDcode2 and do not support any other control type. These products can be used in combination with any LEDcode2 peripheral such as a Bluetooth radio, and are marked with a blue dot in the product overview.



Wireless Solution With Bluetooth Radio

Wireless lighting with eldoLED is easy with our Bluetooth Low Energy (BLE) radios. eldoLED's BLE radios feature a LEDcode2 connection and are compatible with our DALI and LEDcode2-only drivers. Lighting control is easily managed using an SDK mobile application from Casambi or Atrius.

Application configurations include:

- Through-ceiling installation with integrated antenna
- In-luminaire installations with integrated or external antenna

For more information, please visit <http://eldoLED.com/wireless>.



A driver with Bluetooth radio (Casambi or Atrius ready)



LightShape

Our LightShape technology takes the complexity out of dynamic white lighting and allows you to create intuitive Tunable White and Dim to Warm lighting applications with standard controls, drivers and LED modules. In the product overview, you can see products that include LightShape technology for either Dim to Warm or Tunable White applications.

For more information on LightShape, please visit www.eldoled.com/lightshape.

ENEC Certified LED Drivers

Form Factor	Constant Current													
	ECOdrive							SOLOdrive						
	A	B	M	L	P	S	U	A	B	M	L	P	S	U
10W		●				●			●				●	
20W	●	●	●			●	●	●	●	●			●	●
30W	●	●		●		●	●	●	●		●		●	●
32W					□							□		
50W	●	●				●	●	●	●		●		●	●
75W				●							●			
100W			●			●		●		●			●	
120W														
180W														
200W														
720W														

- 0-10V
- DALI
- LEDcode2 only
- DMX
- Pulse dimming

Form Factor	DUALdrive										POWERdrive				Constant Voltage LINEARdrive		
	A	M	L	P	S	U	A	M	S	U	A	M	S				
	10W																
20W	●	●				●											
30W						●											
32W				□													
50W	●		●		●	●	●				●						
75W			●														
100W	●	●			●		●	●	●	●	●	●	●	●	●	●	
120W		●															
180W														●			
200W														●	●	●	
720W														●	●		

- DC powered product (needs a separate power supply)
- LightShape: for Tunable White applications
- LightShape: for Dim to Warm applications

UL Listed, Class P Certified LED Drivers

		Constant Current															
		ECOdrive				SOLOdrive				DUALdrive				POWERdrive			
Form Factor		B	L	S	U	B	L	S	U	B	L	S	U	A	S	U	
Output Power	20W				● ●				● ●				● ●				
	30W	● ● ●		● ●	● ● ●	● ● ●		● ● ●	● ● ●	● ● ●		● ● ●	● ● ●				
	50W		● ● ●		● ● ●		● ● ●				● ● ●		● ● ●	● ● ●	● ● ●		
	75W	● ● ●	● ● ●			● ● ●	● ● ●				● ● ●						

All our UL listed, Class P certified drivers are CA Title 24 compliant (start-up time).

- 0-10V
- DALI
- LEDcode2 only
- DMX

- DC powered product (needs a separate power supply)
- LightShape: for Tunable White applications
- LightShape: for Dim to Warm applications

UL Recognized LED Drivers

Form Factor	Constant Current														Constant Voltage													
	ECOdrive							SOLOdrive							DUALdrive					POWERdrive					LINEARdrive			
	A	B	M	L	P	S	U	A	B	M	L	P	S	U	A	M	L	P	S	U	A	M	R	S	U	A	M	S
10W		● TL ●				● TL ●			● TL ●					● TL ●														
15W	●																											
20W		● TL ●				● TL ●	● TL ●		● TL ●					● TL ●	● TL ●						● TL ●							
30W	● ● ● ●	● TL ●		● TL ●		● TL ●	● TL ●	● ● ● ●	● TL ●			● TL ●	● TL ●	● TL ●	● TL ●						● TL ●							
32W					●								●						●									
45W	●																				● ●							
50W	● ● ● ●	● TL ●		● TL ●		● TL ●	● TL ●	● ● ● ●	● TL ●			● TL ●	● TL ●	● TL ●	● TL ●	● TL ●		● TL ●		● TL ●	● TL ●							
75W				● TL ●							● TL ●							● TL ●										
90W																					● ●							
100W			● TL ●			● TL ●			● TL ●	● TL ●				● TL ●	● TL ●	●	● TL ●			● TL ●	● TL ●	● ●	● ●	● ●	● ●	● ●		
180W																					● ●			● ●				
200W																								● ●				
600W																						● ●						
720W																								● ●				

- 0-10V
- DALI
- LEDcode2 only
- DMX
- TL Type TL certification
- CA Title 24 compliant (start-up time)

Form Factor	Constant Current														Constant Voltage													
	ECOdrive							SOLOdrive							DUALdrive					POWERdrive					LINEARdrive			
	A	B	M	L	P	S	U	A	B	M	L	P	S	U	A	M	L	P	S	U	A	M	R	S	U	A	M	S
10W																												
15W																												
20W																					● TL ●							
30W																					● TL ●							
32W																												
45W																												
50W																● TL ●		● TL ●		● TL ●	● TL ●							
75W																		● TL ●										
90W																												
100W																●	● TL ●			● TL ●	● TL ●	● ●	● ●	● ●	● ●	● ●		
180W																					● ●			● ●				
200W																								● ●				
600W																								● ●				
720W																								● ●				

- DC powered product (needs a separate power supply)
- LightShape: for Tunable White applications
- LightShape: for Dim to Warm applications

BIS Certified LED Drivers

		Constant Current															Constant Voltage			
		ECOdrive					SOLOdrive					DUALdrive				POWERdrive			LINEARdrive	
Form Factor		A	B	M	L	S	A	B	M	L	S	A	L	S	U	A	M	S	A	
Output Power	20W	●●		●●			●●		●●											
	30W	●●					●●													
	50W	●●	●		●	●●	●●	●●		●		●	●	●●	●					
	100W						●●		●●							●●	●●	●●	●●	●
	180W																		●	
	200W																		●●	
	720W																		●●	

TISI Certified LED Drivers

		Constant Current																	
		ECOdrive						SOLOdrive					DUALdrive				POWERdrive		
Form Factor		A	B	M	L	S	U	A	B	M	L	S	A	L	S	U	A	S	U
Output Power	20W	●●		●●				●●		●●									
	30W	●●						●●											
	50W	●●	●		●●	●●	●	●●	●●		●		●	●	●●	●	●	●	●

- 0-10V
- DALI
- LEDcode2 only
- DMX

- DC powered product (needs a separate power supply)
- LightShape: for Tunable White applications
- LightShape: for Dim to Warm applications

RCM Certified LED Drivers*

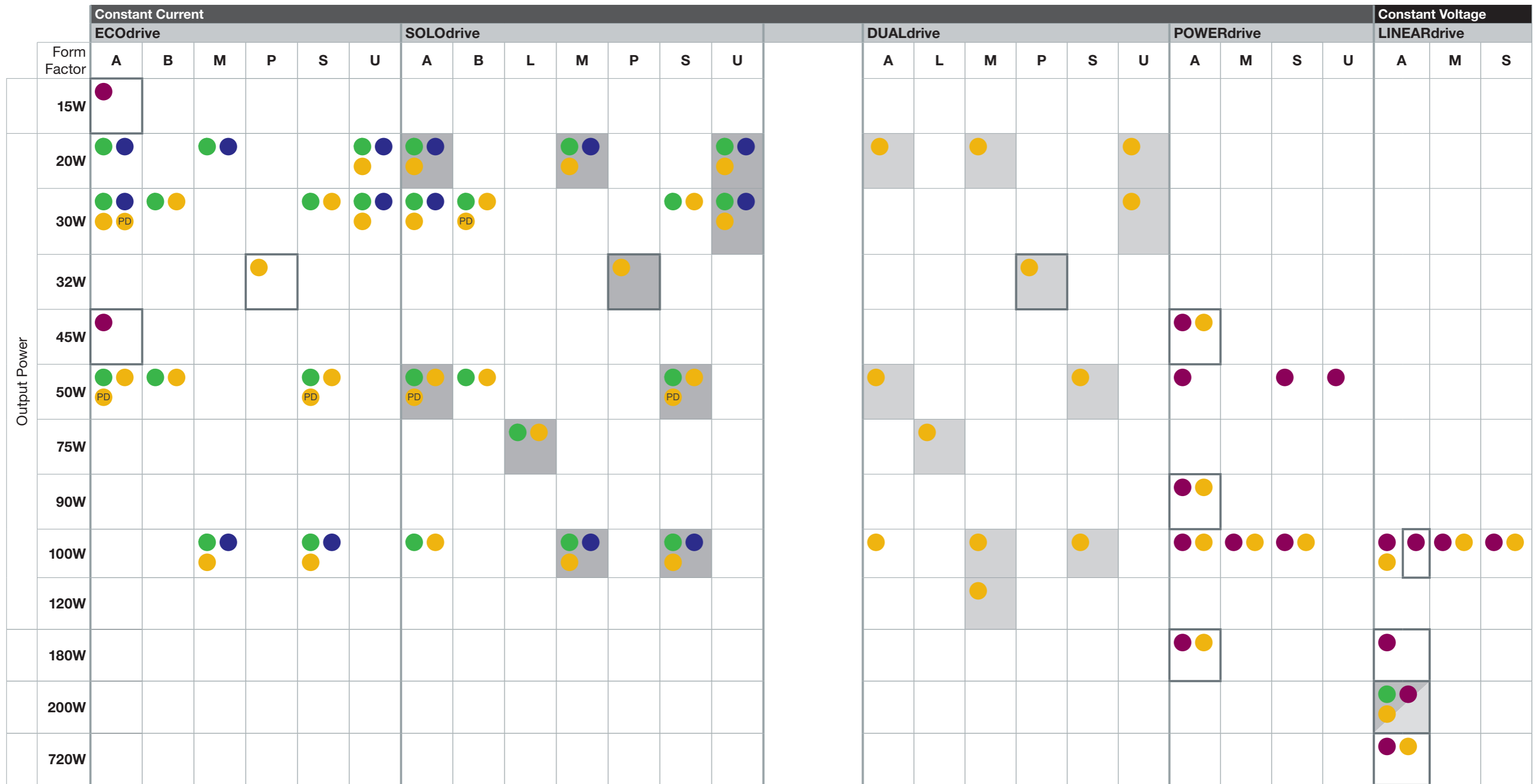

* For our DC drivers RCM certification is not required according to the official guidelines.

- 0-10V
- DALI
- LEDcode2 only
- DMX
- PD Pulse dimming

- DC powered product (needs a separate power supply)
- LightShape: for Tunable White applications
- LightShape: for Dim to Warm applications

PSE Certified LED Drivers**

		Constant Current						Constant Voltage
		ECOdrive		SOLOdrive		DUALdrive		POWERdrive
Form Factor		A	P	A	P	A	P	A
Output Power	15W	●						
	30W	● ● ● PD		● ● ● PD				
	32W		●		●	●		
	45W	●					● ●	
	50W	● ●		● ●		●		
	90W						● ●	
	100W							●
	180W						● ●	●
	200W							● ● ●
	720W							● ●

** Our DC drivers have an input voltage lower than 50V DC, therefore PSE certification is not required according to the official guidelines.

- 0-10V
- DALI
- LEDcode2 only

- DMX
- PD Pulse dimming

KC Certified LED Drivers

		Constant Current		
		ECOdrive	SOLOdrive	DUALdrive
Form Factor		A	A	A
Output Power	20W	● ● ● PD ●	● ● ● PD ●	
	30W	● ● ● PD ●	● ● ● PD ●	
	50W	● ● ● PD	● ● ● PD	●

- DC powered product (needs a separate power supply)
- LightShape: for Tunable White applications
- LightShape: for Dim to Warm applications

Standards & Certifications

eldoLED LED drivers are high quality products that comply with regional and global industry standards. Below is an overview of the industry standards and concepts with which eldoLED is compliant.



BIS (India)

BIS is the safety certification for India. The figure at the bottom of the label indicates the number of the certificate.



ENEC (Europe)

ENEC is the safety certification for Europe and defines requirements for preventing electrical shock and fire.



There are two categories:

ENEC label

- A standard ENEC label indicates that the LED driver has passed the standard ENEC safety test with AC mains voltage
- The standard reference is EN61347-1
- The digits in the label ('05') are the lab identification number

EL label

- An EL label indicates that the driver has also passed the test with DC mains voltage for emergency lighting
- The standard reference is EN-61347-2-13



UKCA (United Kingdom)

UKCA is the product marking for Great Britain as of January 1, 2021.

As of January 1, 2022 a UKCA label is required for goods placed in Great Britain. Until that date, the CE label is sufficient.



CE (Europe)

CE marking is an administrative marking with which the manufacturer or importer affirms its conformity with European health, safety and environmental protection standards for products sold within the European Economic Area. It is not a quality indicator or a certification mark.



KC (South Korea)

KC is the safety certification for electrical and electronic equipment that is intended for the South Korean market.



PSE (Japan)

PSE is the safety standard for Japan. PSE certified products have this label.



RCM (Australia/NZ)

RCM is a certification for New Zealand and Australia. It consists of basic ENEC certification with additional testing for RCM. The standard references are SAA 61347.1 and SAA 61347.2.13.

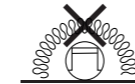

There are two RCM labels:

- Standard RCM label
- Label for independent drivers. The LED driver is a standalone driver and should not be covered with isolation material



TISI (Thailand)

TISI is the safety standard for Thailand. The digits below the label are the certificate number.



UL (North-America)

UL is a North American safety standard that defines requirements for preventing electrical shock and fire from LED drivers.



There are three categories:

UL recognized

- This is the basic UL certification
- The LED driver is a UL recognized component and only intended for use in other end-use products
- The standard references are UL8750 and UL1310
- In the label, 'C' is for Canada and 'US' for United States of America
- The code 'E333135' at the bottom is the company identification number for eldoLED

UL recognized, type TL

- The LED driver is a UL recognized component. In addition to standard UL certification, the LED driver has been tested on Tref and TrefMax value

UL listed, Class-P

- The LED driver is a UL listed product that can be used as end-use product
- In addition to standard UL certification, the LED driver has been tested on temperature protection

Lighting Controls Protocols



DALI-2

DALI-2 is an international standard for the DALI dimming protocol. Compared to DALI version-1 devices current on the market, DALI-2 certified components bring the promise of significantly improved interoperability and additional functionality.

For more information: <https://www.digitalilluminationinterface.org/certification/>



DMX

The international standard reference for DMX dimming is ANSI E1.20 and E1.11 – 2008, USITT DMX512-A.



0-10V Dimming

The international standard for 0-10V dimming is IEC 60929 annex E; for Europe EN 60929 annex E.

Compliance of eldoLED drivers:

- Below 0.6V: enabling standby mode
- From 0.6V to 10V: with IEC/EN 60929 annex E

For detailed dimming characteristics see the 0-10V response chart in the Control Characteristics section of the product datasheets.



Casambi

Protocol for wireless communication, based on Bluetooth Low Energy. A wireless mesh network can be created to control the fixtures that are included.



Pulse Dimming

Pulse dimming is a feature on eldoLED DALI drivers that enables easy switching and dimming. Pulse dimming uses standard mains voltage (max 250V AC) switches for lighting control.

Form Factor Overview

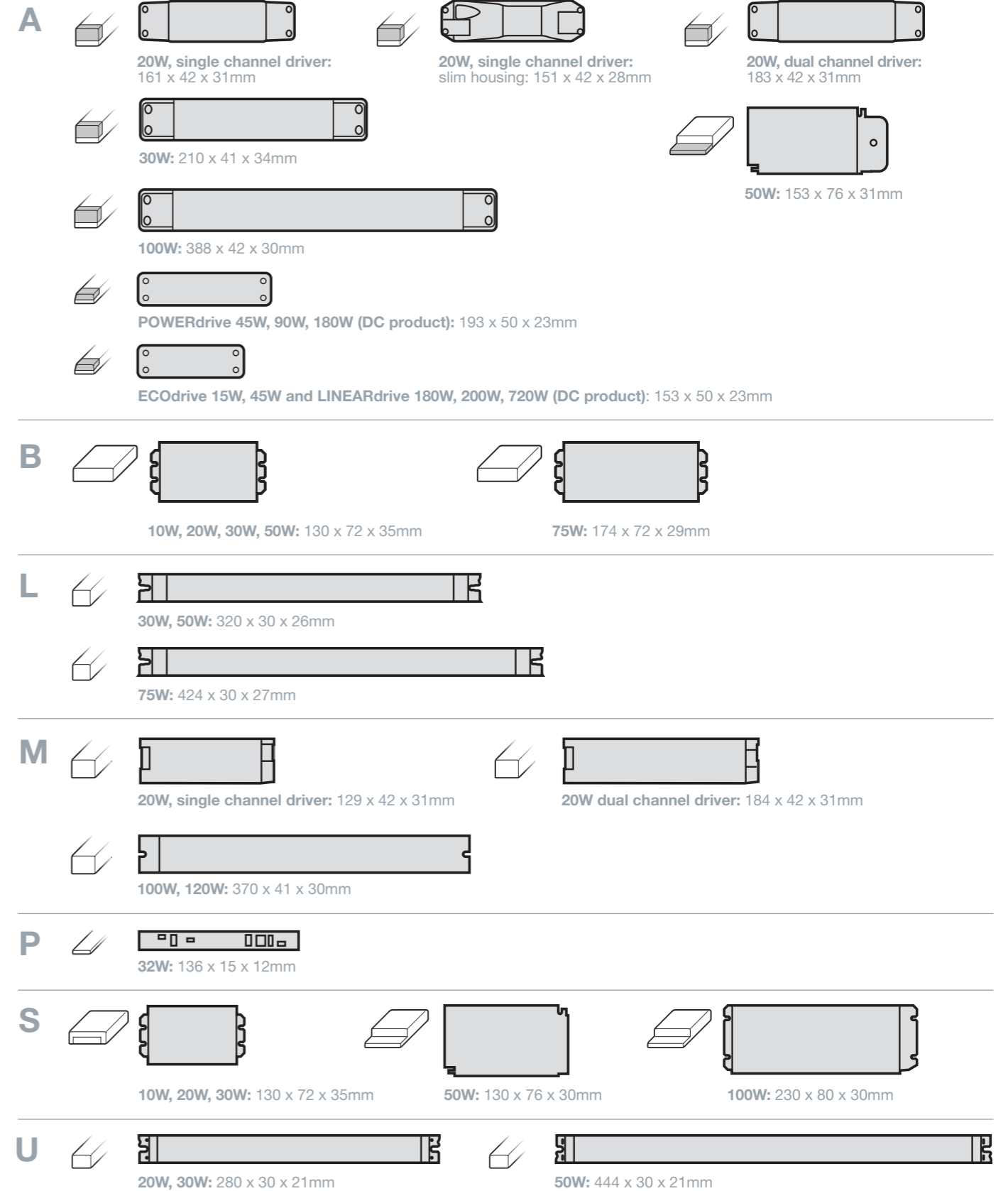

eldoLED Europe

Science Park Eindhoven 5125
5692 ED Son
The Netherlands
T: +31 (0)40 782 04 00
E: sales@eldoled.com

eldoLED North-America

One Lithonia Way
Conyers, GA 30012
United States
T: +1 877 eldoLED (+1 877 353 6533)
E: nasales@eldoled.com

eldoLED Asia-Pacific / Beyond Illumination

25 Tagore Lane
#03-06, Singapore G Building
Singapore 787602
T: +65 6455 0018
E: sales@beyondillum.com