

DATE	PROJECT	FIRM	TYPE
------	---------	------	------

THE L50 INCLUDES PATENTED OPTICAL DESIGN THAT DELIVERS THE WIDEST RANGE OF BEAM ANGLE OPTIONS FOR PRECISE COVE, WALL GRAZING, WALL WASHING OR LINE OF LIGHT APPLICATIONS. EXCLUSIVE FLIP TO FLAT™ HINGE DESIGN PROVIDES FLEXIBILITY WHEN MANAGING SMALL COVE DETAILS. TRÖV OFFERS SMOOTH, FLICKER FREE DIMMING DOWN TO 0%.

FEATURES :

- DIM TO 0%, ELV REVERSE PHASE
- 24 BEAM ANGLES
- MULTI-VOLT
- FLIP TO FLAT™
- 6 CCT OPTIONS
- 80+ AND 90+ CRI OPTIONS
- IP66 EXTERIOR OPTIONS

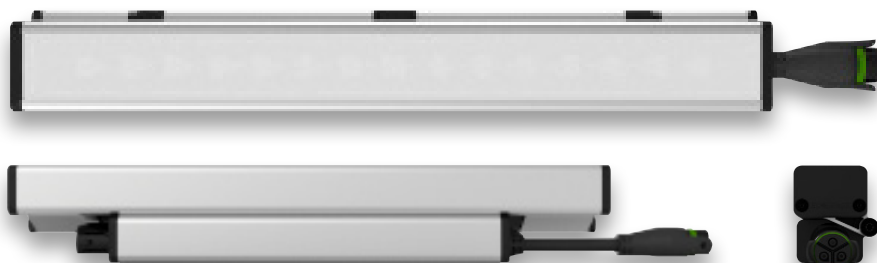

MODEL/ SIZE	INTERIOR/ EXTERIOR	LENGTH	POWER	CCT	CRI	VOLTAGE	OPTICS
L50	E	12" 48"	02 04 06 08 10 12	WHITE CCT 22 27 30 35 40 50	MONO COLOR GR**** BL AM RD***	80 90* Blank For Color	MULT (120-277V) GRAZING 9 x 9 9 x 17 9 x 29 9 x 59 15 x 15 15 x 23 15 x 35 15 x 65 COVE 120** Asym LINE OF LIGHT LOL WASHING 25 x 25 25 x 33 25 x 45 25 x 75 39 x 9 55 x 25 40 x 40 40 x 48 40 x 60 40 x 90 45 x 15 70 x 40 70 x 70

EXAMPLE: L50-E-48-10-27-90-MULT-15x65 *90 CRI not available in 2200K or 5000K **120 is only available with Exterior option. See L35 spec sheet for interior cove options. ***Red is not available in 12W or 10W. ****Green is not available in 12W.

PERFORMANCE	WATTS	OPTIC	LUMEN OUTPUT	EFFICACY
	2W	120°	95 lm/LF (311 lm/m)	48 lm/W
	4W	120°	273 lm/LF (895 lm/m)	68 lm/W
	6W	120°	426 lm/LF (1397 lm/m)	71 lm/W
	8W	120°	586 lm/LF (1922 lm/m)	73 lm/W
	10W	120°	697 lm/LF (2286 lm/m)	70 lm/W
	12W	120°	807 lm/LF (2647 lm/m)	67 lm/W





ALL LUMEN DATA IS FROM 4000K 80CRI FIXTURES. PLEASE SEE PHOTOMETRY SPEC SHEET FOR ADDITIONAL LUMEN DATA.

COLOR RENDERING INDEX	80+, 90+				
COLOR CONSISTENCY	2-STEP MACADAM ELLIPSE				
LUMEN DEPRECIATION / RATED LIFE	WATTS	L70 @ 25C	L70 @ 50C	L90 @ 25C	L90 @ 50C
	2W-12W	>150,000	>70,000	>50,000	>25,000

* CALCULATIONS FOR LED FIXTURES ARE BASED ON MEASUREMENTS THAT COMPLY WITH IES LM-80 TESTING PROCEDURES AND IES TM-21 CALCULATOR

ELECTRICAL	POWER CONSUMPTION	2W*/LF (6.6W/M) ; 4W/LF (13.2W/M) ; 6W/LF (19.8W/M) ; 8W/LF (26.4W/M) ; 10W/LF (33W/M) ; 12W/FL (39.6W/M) * 3W/LF (9.9W/M) at 220V -277V												
		MAX FIXTURE RUN LENGTH												
		2W/LF		4W/LF		6W/LF		8W/LF		10W/LF		12W/LF		
		Volts	Max Run all 1'	Max Run all 4'	Max Run all 1'	Max Run all 4'	Max Run all 1'	Max Run all 4'	Max Run all 1'	Max Run all 4'	Max Run all 1'	Max Run all 4'	Max Run all 1'	Max Run all 4'
		120	214	214	186	186	152	152	114	114	91	91	76	76
		220	374	392	340	340	277	277	209	209	95	167	95	139
		277	374	494	374	428	349	349	263	263	95	190	95	175
	POWER FACTOR	4W, 6W, 8W, 10W, 12W >0.9, 2W<0.9												
	OPERATING VOLTAGE DRIVER	MULTIVOLT: 110-277VAC, 50/60 Hz												
	STARTUP TEMPERATURE	INTEGRAL TO FIXTURE; DE-RATED POWER AND SYNCHRONOUS START-UP AT FULL BRIGHTNESS												
	OPERATING TEMPERATURE	-40°F TO 122°F (-40°C TO 50°C)												
	STORAGE TEMPERATURE	-40°F TO 176°F (-40°C TO 80°C)												

NOTE: Information on this Spec Sheet is subject to change, please visit ecosenselighting.com/downloads/rise for the most updated information.

DATE	PROJECT	FIRM	TYPE
CONTROL	DIMMING	110-277VAC, ELV TYPE 0.07%-100%, REVERSE PHASE, TRAILING EDGE ETC control systems require 0-10V control using EcoSense LDCM. TROV will not work with ETC phase dimmers.	
PHYSICAL	DIMENSIONS HOUSING /LENS WEIGHT CONNECTORS ENVIRONMENT BEAM ANGLE MOUNTING OPTIONS	W 1.6" x H 2" x L 12"/48"; (41.6mm x 50.5mm x 304.7mm/1201mm) EXTRUDED ALUMINUM; UV STABILIZED POLYCARBONATE; STAINLESS STEEL FASTENERS; PLASTIC ENDCAPS RUBBER OVERMOLD FOR CABLE ASSEMBLY 1.52LBS / 0.69KG (1FT) ; 4.95LBS / 2.25KG (4FT) INTEGRAL MALE/ FEMALE CONNECTORS INDOOR • ETL CERTIFIED FOR DRY/DAMP LOCATIONS IP54 OUTDOOR • ETL CERTIFIED FOR WET LOCATIONS IP66 IMPACT RATED TO IK10 Not intended to be used in water features such as waterfalls, fountains, etc. GRAZING, WASHING, COVE, ASYMMETRIC, LINE OF LIGHT INTEGRAL MOUNTING AND ADJUSTABLE AIMING FROM 0°-180° IN 15° INCREMENTS	
FIXTURE RATING & CERTIFICATIONS	CE, ETL CERTIFIED RoHS COMPLIANT ENERGY STAR COMPLIANT RCM CERTIFIED	    	
LIMITED WARRANTY	5 YEARS	Title 24 JA8-2016 *90 CRI models only	

WIRING OPTIONS (MVOLT): 110-277VAC

Power Cable Assembly, TROV, Leader/Jumper, 10 foot.....	CBL-3P-L-UNV-10*
Power Cable Assembly, TROV, Leader/Jumper, 50 foot.....	CBL-3P-L-UNV-50*
Power Cable Assembly, TROV, Jumper, 5 foot.....	CBL-3P-L-UNV-05**
Power Cable Assembly, TROV, Jumper, 1 foot	CBL-3P-L-UNV-01**
Power Cable Assembly, TROV, Adjustable Jumper, 0" to 7"	CBL-3P-L-UNV-ADJ
Power Cable Assembly, TROV, Male and Female terminator caps.....	CBL-3P-L-UNV-CAPS

*Two (2) terminators are included with the 10' and 50' power cable. One Leader need per circuit/fixture run. Cables are not plenum rated.
** If using the 5' or 1' power cable assembly as a leader to power a run one set of CBL-3P-L-UNV-CAPS will also be need per cable.

0-10V CONTROL OPTIONS

100-120VAC / 277VAC Linear Dimming Control Module 0-10V - Plenum Rated	LDCM-PL-120-277-010V-GR
--	-------------------------

All products come standard with ELV dimming capabilities. 0-10V Control options required for operation at 0-10V.

OPTIONAL ACCESSORIES

Mounting

Mounting Track and Clips Set, 48 Inch Track, 8 Clips.....	MNT-L-TRKCLIP-48	48" track and clips set will work with one 48" fixture or four 12" fixtures. (FOR INTERIOR USE ONLY)
Mounting Track and Clips Set, 12 Inch Track, 2 Clips.....	MNT-L-TRKCLIP-12	12" track will not work with 48" fixtures. (FOR INTERIOR USE ONLY)
Mounting Track Clip, TROV, Set of 2.....	MNT-L-CLIP	Clips needed = 12" fixtures need 1 set of 2 and 48" fixture needs 2 sets of 2.
90 Degree L bracket, TROV, Set of 2.....	MNT-L-LBKT	L-Brackets needed = 12" fixtures need 1 set of 2 and 48" fixture needs 1 set of 2.
Angle Locking Clip, TROV, Pack of 10.....	MNT-L-ANGLOCK	Angle Locks needed = 12" fixtures need 1 and 48" fixtures need 2. (Must order separately)
Mounting, Fine Adjustment Bracket, TROV	MNT-L-FAB	Fine Adjustment Brackets needed = 12" fixtures need 1 and 48" fixtures need 2. *Fine Adjustment Bracket is highly recommended for Grazing Optics.
Mounting, Fine Adjustment L-Bracket, TROV	MNT-L-LFAB	Fine Adjustment L-Brackets needed = 12" fixtures need 1 and 48" fixtures need 2. *Fine Adjustment L-Bracket is recommended for Asymetric Optics when aiming is needed.

Snap-on Lenses

Snap-on Lens, Frosted, 12 inch, L50	LENS-L50-FROST-12	Snap-on Lenses need = One 12" lens is needed per 12" fixture and one 48" lens is needed per 48" fixture. Snap on Lenses will not work with the asymmetric fixture. Clear lenses can be used to hold colored filters to customize the output color of any TROV fixture, except the ASYM. Color filters supplied by others.
Snap-on Lens, Frosted, 48 inch, L50	LENS-L50-FROST-48	
Snap-on Lens, Clear, 12 inch, L50	LENS-L50-CLEAR-12	
Snap-on Lens, Clear, 48 inch, L50	LENS-L50-CLEAR-48	

Wall Mount Arm

Wall Mount Arm, 6 inch, TROV	WMA-L-CA-06	Wall Mount Arms needed = For individual fixture installations two arms and one end set will be needed per fixture. For continuous run installation one endset will be needed per run. Each end set contains one left and one right end plate. One joining set will be needed per joint. One arm per fixture will be need plus one extra arm to complete the run. For example: A 10ft run made with two 4ft and two 1ft fixtures will contain; 1 x WMA-L-END, 3 x WMA-L-JNR, and 5 x WMA-L-CA-12. Leader cables are not included with wall mount arms, end sets, or joiners sets.
Wall Mount Arm, 12 inch, TROV.....	WMA-L-CA-12	
Wall Mount Arm, 18 inch, TROV.....	WMA-L-CA-18	
Wall Mount Arm, 24 inch, TROV.....	WMA-L-CA-24	
Wall Mount Arm End Plate Set, TROV, Includes Left and Right.....	WMA-L-END	
Wall Mount Arm Joiner Plate, TROV	WMA-L-JNR	

Louvers

Louver, Asymmetric, 12 inch, L50	LV-L50-ASYM-12	Louvers Needed = One 12" louver is needed per 12" fixture and one 48" louver is needed per 48" fixture. 48" louver is made up of four 12" louvers. Louvers cannot be used with the asymmetric fixture
Louver, Asymmetric, 48 inch, L50	LV-L50-ASYM-48	
Louver, Symmetric, 12 inch, L50	LV-L50-SYM-12	
Louver, Symmetric, 48 inch, L50	LV-L50-SYM-48	
Louver, Honeycomb, 12 inch, L50	LV-L50-HCOMB-12	
Louver, Honeycomb, 48 inch, L50	LV-L50-HCOMB-48	

DATE	PROJECT	FIRM	TYPE
------	---------	------	------

OPTIONAL ACCESSORIES

Masking Plates

- Masking Plate, 3 inch high, 12 inch, L50 & L35 MP-L50-3H-12
- Masking Plate, 3 inch high, 48 inch, L50 & L35 MP-L50-3H-48

Masking Plates needed = One 12" plate is needed per 12" fixture and one 48" plate is needed per 48" fixture.

Landscape Stake

- Landscape Stake, 6 inch, TROV, Set of 2 LS-L-STK-06
- Landscape Stake, 12 inch, TROV, Set of 2 LS-L-STK-12
- Landscape Stake, 18 inch, TROV, Set of 2 LS-L-STK-18

Landscape Stakes needed = 12" and 48" fixtures both need one set of 2.

DIMENSIONS + MOUNTING

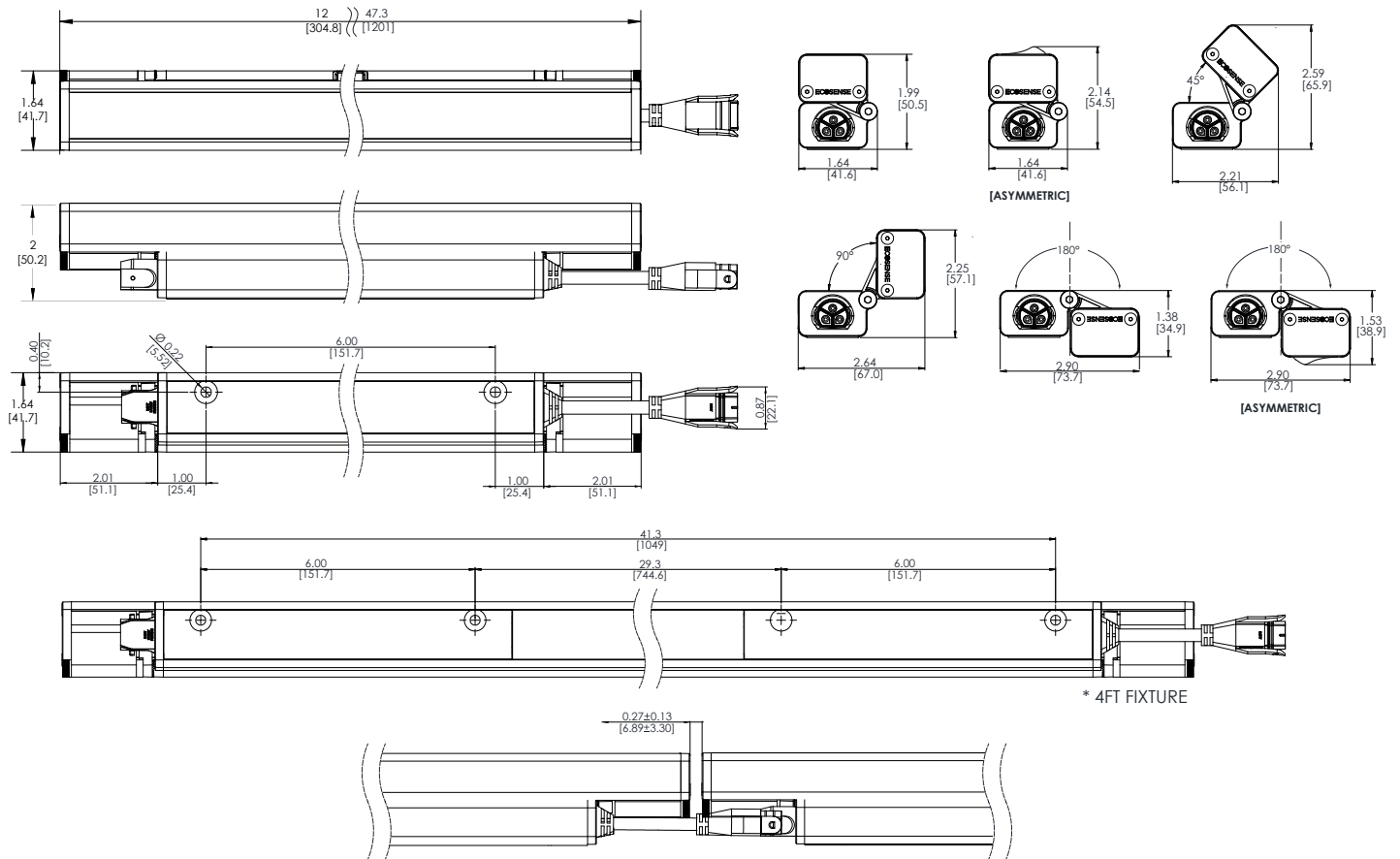

Fine Adjustable Bracket:

