



Light
is our passion

20W DALI-2 'Dim to Dark' LED Driver

SOLOdrive

LED dimming made beautiful - SOLOdrive offers industry-best Natural Dimming to dark, with any dimmer, in any application. The SOLOdrive works seamlessly with LED modules, controls and intelligent luminaire elements.

Product offering



SOLOdrive 240/A

Part number (P/N)	SL0240A3
Product description	SOLOdrive, 20W, DALI-2, Pulse dimming, 1 control channel, constant current, 1x 40V output, side feed, long plastic

SOLOdrive 240/A (Single Package Option)

Part number (P/N)	SL0240A3-SP
Product description	SOLOdrive, 20W, DALI-2, Pulse dimming, 1 control channel, constant current, 1x 40V output, side feed, long plastic, single unit packaging

Features & benefits

Natural dimming	Dim to dark, smooth brightness changes, excellent flicker performance, adaptable dimming curves, configurable minimum dimming level
LEDcode	LEDcode2 connects to integrated digital accessories, supports location-based IoT applications and enables wired and wireless lighting control through LEDcode peripheral devices
Programmable	Fine-tune your driver for any application
Performance	Low inrush current and total harmonic distortion (THD), high power factor and efficiency
Camera compatibility	Hybrid HydraDrive technology is proven to work in TV studios and security camera environments
Pulse dimming	Different switching and dimming functions are initiated by pressing and holding the standard mains voltage switch for varying lengths of time

Programming tools

Programming interface	TOOLbox pro (TLU20504)
Programming cable set	TOOLbox pro to LED driver, programming cable, 5pcs (TLC03051)
Programming Hand-held, Touch-and-Go	PJ0035HH1
Programming jig	PJ0200A1
Programming software	FluxTool

Warranty

Warranty period	General Terms and Conditions
-----------------	--

Order number configurator

SL0240A3

Part Number

mA

LED Output Current

Dimming Curve

. min

Minimum Dimming Level

LED output current	Enter value in 1mA increments, e.g. "811" for 811mA
Dimming curve	"LOG" for logarithmic (default) "LIN" for linear
Minimum dimming level	Leave blank for default minimum dimming level of 0.1%. Specify in 0.1% increments, e.g. "10.5" for 10.5%.

Input characteristics

Nominal input voltage range	220 - 240 VAC (ENEC) 176 - 250 VDC
-----------------------------	---------------------------------------

Absolute input voltage range	198 - 264 VAC
------------------------------	---------------

Input frequency range	50 - 60 Hz
-----------------------	------------

Maximum input current	0.15A @ 230 VAC
-----------------------	-----------------

Efficiency at full load	80%
-------------------------	-----

Power factor at full load	> 0.95
---------------------------	--------

THD at full load	< 20%
------------------	-------

Maximum inrush current	< 200mA ² s @ 230 VAC
------------------------	----------------------------------

Surge protection	2kV differential mode (DM) 2kV common mode (CM)
------------------	--

Maximum standby power	< 0.5W
-----------------------	--------

Output characteristics

Maximum LED output power	20W
Number of LED outputs	1
Programmable LED output current range	150 - 1050mA
LED output type	Programmable in 1mA increments within specified current range
LED output current tolerance	+/- 5% at programmed LED output current
LED output voltage range	2 - 40V

Operating window

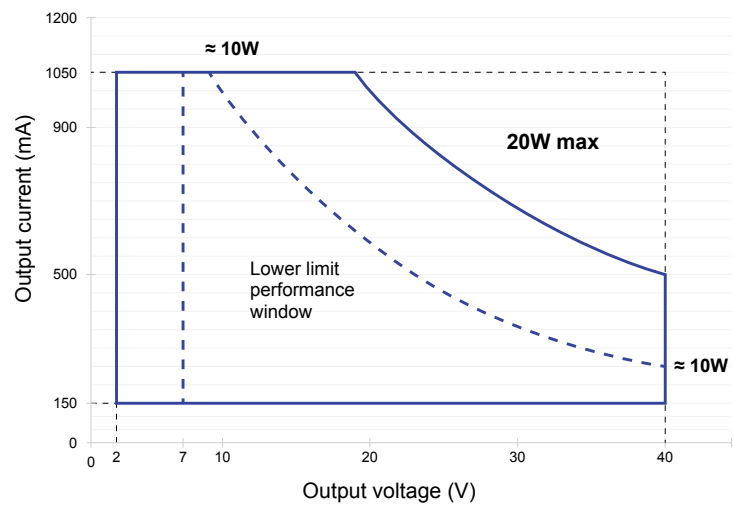

Control characteristics

Control channels	1
Control protocol	DALI-2 Device type 6 & Pulse dimming LEDcode2
Dimming range	100% - 0.1%
Dimming curve options	Logarithmic (default) Linear
Dimming method	Hybrid HydraDrive
Time delay to standby	< 60s

Dimming curves

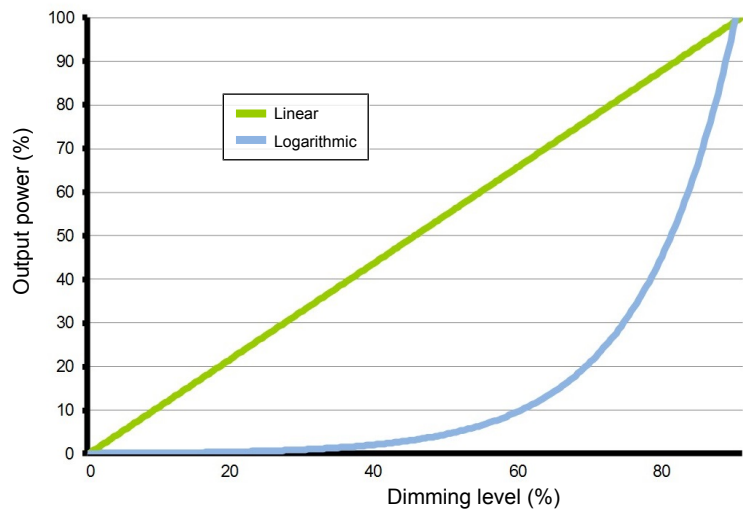

Pulse dimming control

End-user functionality & Installation requirements	Detailed explanation in the eldoLED Quick Start Guide
LEDcode compatibility	In an installation using Pulse dimming, LEDcode functionality cannot be used with a Bluetooth radio, sensor, or other LEDcode devices
Supported input voltage range AC	100 – 250V

Performance

Typical efficiency vs load

Tested with a load of 12 LEDs in series, programmed for 500mA and at 25 °C ambient temperature. The measurements below 20W were performed by dimming the light output.

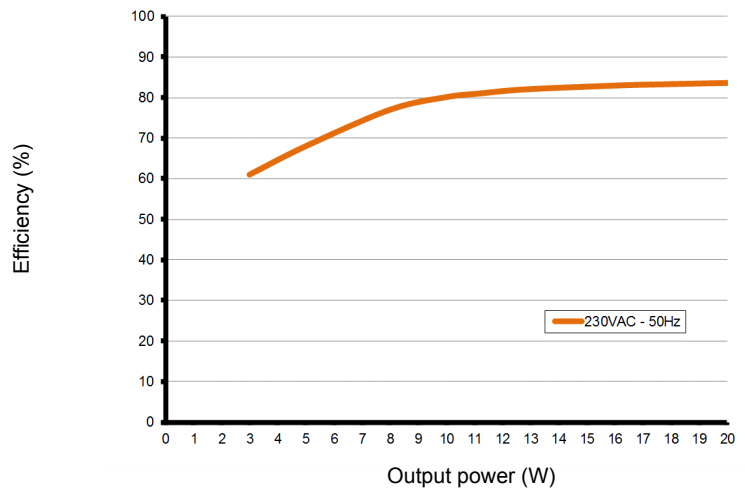

Typical power factor vs load

Tested with a load of 12 LEDs in series, programmed for 500mA and at 25 °C ambient temperature. The measurements below 20W were performed by dimming the light output.

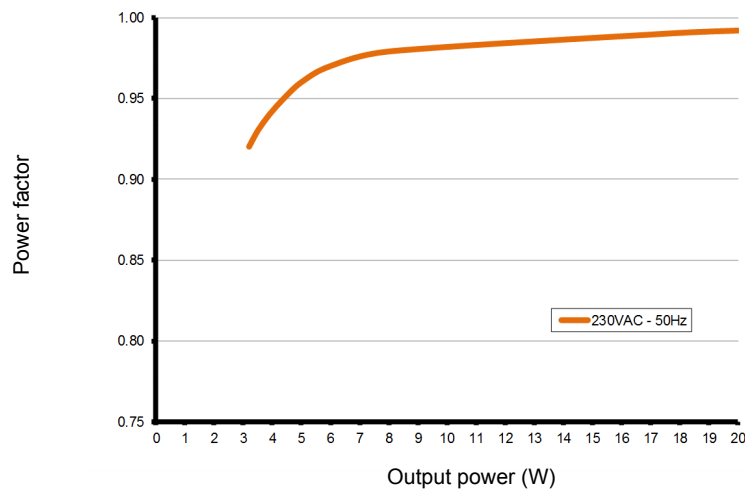

Typical THD vs load

Tested with a load of 12 LEDs in series, programmed for 500mA and at 25 °C ambient temperature. The measurements below 20W were performed by dimming the light output.

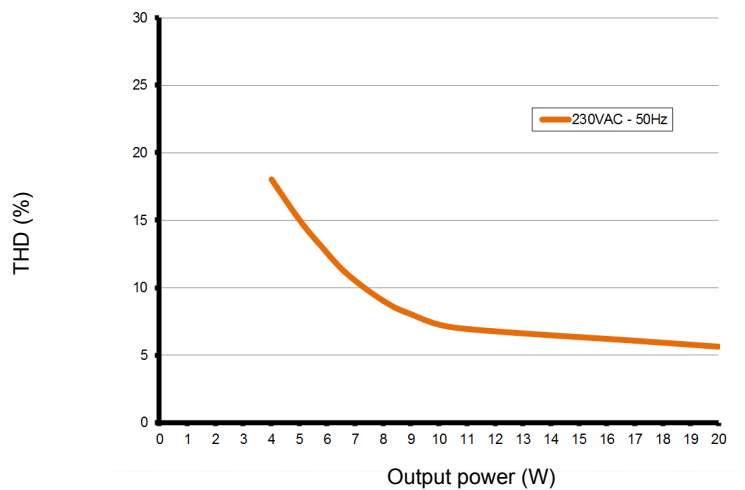

Typical flicker performance

Typical flicker percent as a function of frequency, measured across the dimming range. The results are overlaid with the low-risk (yellow) and no observable effect (green) levels as defined in IEEE P1789.

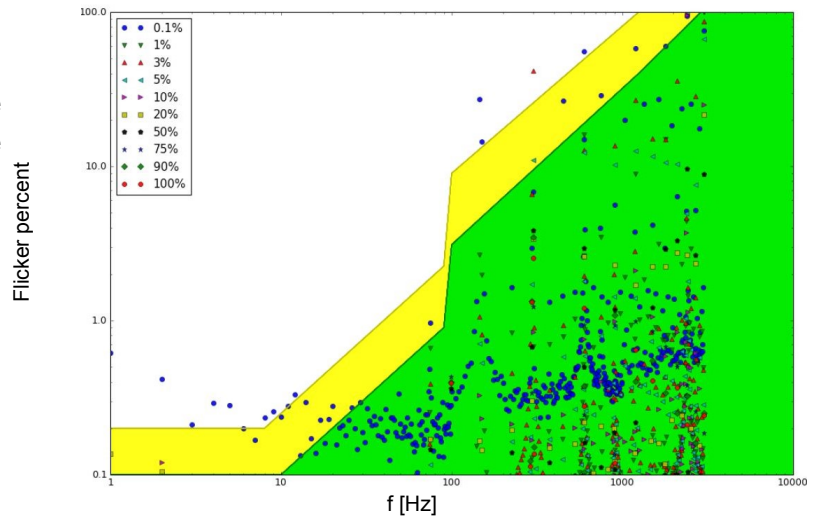

Environmental conditions

Operating ambient temperature (Ta) range	-20 °C to +50 °C for output current ≤ 900mA -20 °C to +43 °C for output current > 900mA
Maximum operating case temperature (Tc max)	80 °C
Acoustic noise – steady state	<24dBA (Class A)
Lifetime	50,000 hours at a maximum case temperature (Tc) of 80 °C

Tc point location

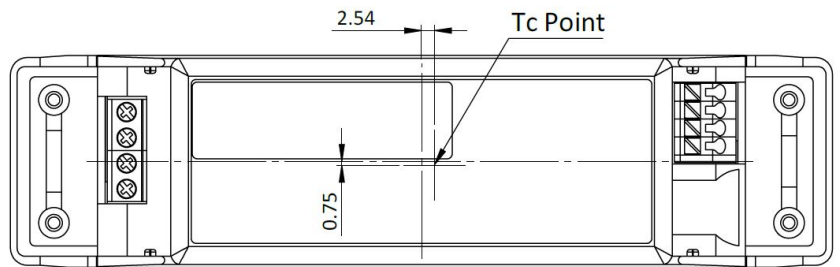

LED driver protection

Thermal	The LED output current is automatically decreased whenever the internal driver temperature exceeds a factory preset temperature. The LED output current is increased once the internal driver temperature drops below the preset temperature threshold. If the internal driver temperature continues to increase, despite a decrease in output current, the LED driver will eventually shut down.
LED output short circuit	The LED output current is cut off whenever the LED driver detects a short-circuit. The LED driver will attempt a restart every 400ms after a short-circuit is detected.
LED output open circuit	The LED output is turned off whenever the LED driver detects an open circuit. The LED driver will attempt a restart every 400ms after an open circuit is detected.
LED output overload	The driver monitors the LED output load. Whenever the output load exceeds the maximum output power rating of the LED driver, the output current is sequentially scaled down until the cumulative load drops below the maximum output power rating of the LED driver.
Reverse polarity	The LED driver will not yield any current if the polarity of the load on the LED output is reversed. This situation will not damage the LED driver but may damage the LED load.

LED protection

Thermal protection LED	An external NTC thermistor, which is placed on a PCB near the LEDs, can be connected to the driver via the LEDcode/NTC terminals. The output current to the LEDs is then decreased by 75% whenever the NTC exceeds a maximum allowable temperature, which is specified by the user in the FluxTool software. The default NTC temperature limit is set to 70 °C.
Thermistor value	47kΩ
Suitable thermistors	Leaded: Vishay, P/N 238164063473 Screw: Vishay, P/N NTCASCWE3473J

LED driver mechanical details

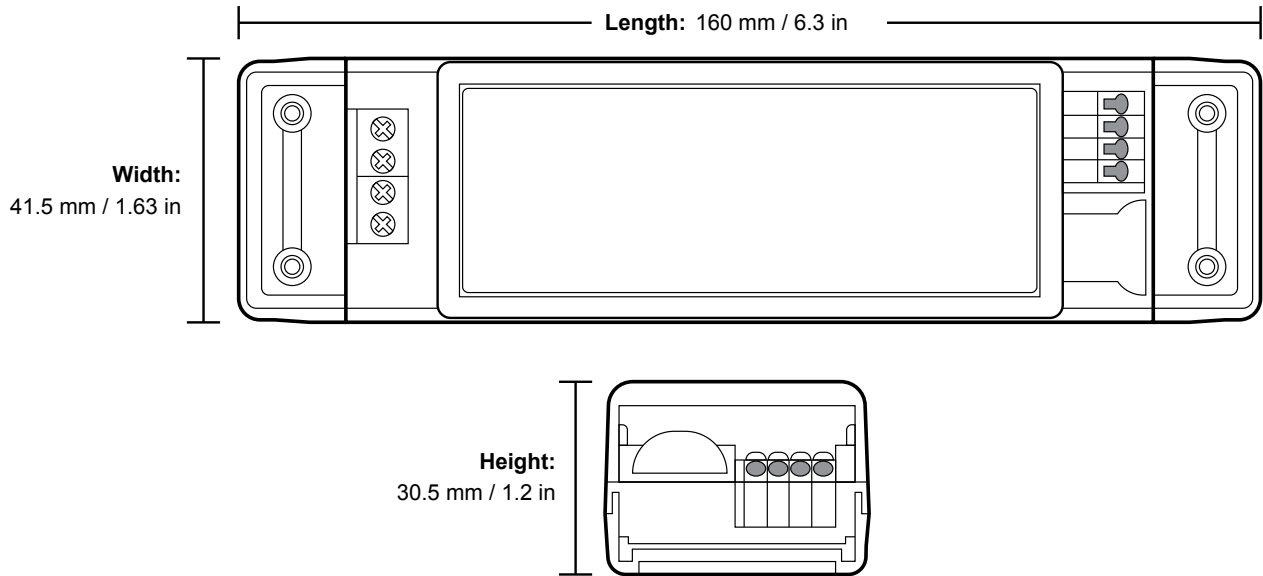

Weight	125 g
Mounting torque	Not to exceed 0.5Nm

3D Mechanical files for this product are available on the eldoLED website.

Packaging

Length x Width x Height	550 x 200 x 200 mm / 21.7 x 7.9 x 7.9 in
Weight (including products)	6.75 kg
Products per box	50 pcs

Connector layout

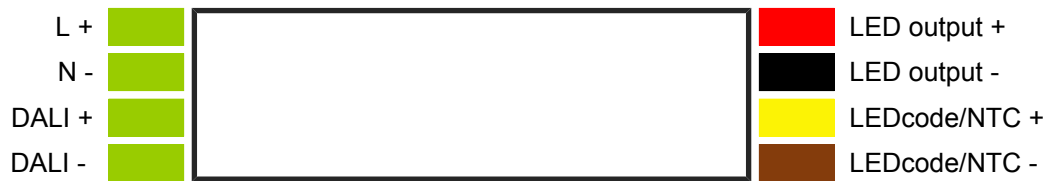

Input wiring specifications

Connector type	screw terminals
Connector supplier and series	TE-Connectivity 2-796683
Wire type	solid or stranded copper
Wire core cross section	0.5 - 3mm ² / AWG 20 - 12
Wire core cross section for RCM	0.75 - 3mm ² / AWG 18 – 12
Wire strip length	9.0mm (11/32in)
Input-cable shape	Round

Output wiring specifications

Connector type	push-in terminals
Connector supplier and series	Wago 250 series
Wire type	solid or stranded copper
Wire core cross section	0.5 - 1.5mm ² / AWG 20 – 16
Wire strip length	9.0mm (11/32in)
Output-cable shape	Round
Maximum remote mounting distance of LED load	<p>For independent use: 2 m / 6.5 ft</p> <p>For in-fixture use:</p> <p>AWG 20 (0.52 mm²) - 14 m / 46 ft</p> <p>AWG 19 (0.65 mm²) - 18 m / 59 ft</p> <p>AWG 18 (0.82 mm²) - 22 m / 72 ft</p> <p>AWG 17 (1.04 mm²) - 28 m / 92 ft</p> <p>AWG 16 (1.31 mm²) - 36 m / 118 ft</p>

Automatic circuit breakers (MCB)

Maximum loading	MCB type	B10	B13	B16	C10	C13	C16
	Number of LED drivers	66	86	106	66	86	106

RCM independent control gear classification

Regulation AS/NZS 60598.2.2

Applies when the control gear is built inside constructions

Clearance type	Description	Distance
Height clearance to building element (HCB)	Minimum distance between the top of the control gear and any building element above it	50 mm
Minimum insulation clearance (MIC)	Minimum distance between the top of the control gear and the building insulation above it	50 mm
Side clearance to building element (SCB)	Minimum distance between the side of the control gear and any building element	50 mm
Side clearance to insulation (SCI)	Minimum distance between the side of the control gear and any building insulation	50 mm

RISK OF FIRE

BUILDING INSULATION MUST NOT COVER THE CONTROL GEAR

Standards and compliance

ENEC safety	EN 61347-1 EN 61347-2-13 (Emergency lighting)
ENEC performance	EN 62384
Conducted emissions	EN 55015
Radiated emissions	EN 55015
Radio disturbance characteristics	EN 55022
Harmonic current emissions	EN 61000-3-2
Electrostatic discharge	EN 61000-4-2
RFE field susceptibility	EN 61000-4-3
Electrical fast transient	EN 61000-4-4
Surge immunity	EN 61000-4-5
Conducted radio frequency	EN 61000-4-6
Voltage dips	EN 61000-4-11
Electromagnetic immunity	EN 61547
ECODesign 2019/2020: Controlgear + luminaire	Flicker for LED: Pst LM ≤ 1.0 at full-load Stroboscopic effect for LED: SVM ≤ 0.4 at full load
DALI-2	IEC 62386-101 Edition 2.0, IEC 62386-102 Edition 2.0, IEC 62386-207 Edition 1
RCM	AS/NZS 61347.1, AS/NZS 61347.2.13
Restriction of hazardous substances	RoHS3 (Directives 2011/65/EU-2015/863/EU)
SVHC-list substances	REACH Art.33

Certifications



Safety



An independent control gear that can be used where normally flammable materials, including building insulation, are or may be present, but cannot be abutted against any material and cannot be covered in normal use.



FELV control terminals marked “Risk of electric shock” are not safe to touch. Dimming connected to FELV control terminal shall be insulated for Low Voltage supply of the control gear. Any terminals connected to the FELV circuit shall be protected against accidental contact.



Risk of electrical shock. May result in serious injury or death. Disconnect power before servicing or installing.



The LED driver may only be connected and installed by a qualified electrician. All applicable regulations, legislation, and building codes must be observed. Incorrect installation of the LED driver can cause irreparable damage to the LED driver and the connected LEDs.

Pay attention when connecting the LEDs: polarity reversal results in no light output and often damages the LEDs.



LED drivers are designed and intended to operate LED loads only. Powering non-LED loads may push the LED driver outside its specified design limits and is, therefore, not covered by any warranty.



eldoLED products are designed to meet the performance specifications as outlined at certain operating conditions in the data sheet. It is the responsibility of the fixture manufacturer to test and validate the design and operation of the system under expected and potential use cases, including faults.



Please observe voltage drop over long cable lengths. Longer cable lengths increase EMI susceptibility.



Product renderings and dimensional drawings are generic for the housing type. Product label, connector type and quantity may vary.

Europe, Rest of World

eldoLED B.V.
 Science Park Eindhoven 5125
 5692 ED Son
 The Netherlands

E: info@eldoled.com
 W: www.eldoled.com

North America

eldoLED America
 One Lithonia Way
 Conyers, GA 30012
 USA

E: info@eldoled.com
 W: www.eldoled.com