



50W 0-10V LED Driver with Smooth Dimming to 1%

ECOdrive

Programmable digital ECOdrive LED driver providing standard LED fixtures with the smoothest flicker-free dimming to 1% light output, delivering value to any application. The LED driver is compatible with the 0-10V lighting control protocol, and works seamlessly together with LED modules, controls and intelligent luminaire elements.

Product offering



ECOdrive 561/A

Part number (P/N)	EC0561A4
Product description	ECOdrive, 50W, 0-10V, 1 control channel, constant current, 1x 55V output, side feed, square metal/plastic

Features & benefits

Natural dimming	Dim to 1%, smooth brightness changes, excellent flicker performance, adaptable dimming curves, configurable minimum dimming level
LEDcode	Configurable design to work with most constant current LED modules and arrays, while providing a connection point to integrated peripheral controls
Programmable	Fine-tune your driver for any application
Performance	Universal input voltage range, low inrush current and total harmonic distortion (THD), high power factor and efficiency
Camera compatibility	Hybrid HydraDrive technology is proven to work in TV studios and security camera environments

Programming tools

Programming interface	TOOLbox pro (TLU20504)
Programming cable set	TOOLbox pro to LED driver, programming cable, 5pcs (TLC03051)
Programming Hand-held, Touch-and-Go	PJ0035HH1
Programming jig	PJ0500S1
Programming software	FluxTool

Warranty

Warranty period	General Terms and Conditions
-----------------	--

Order number configurator

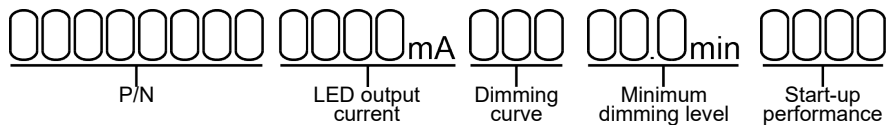

P/N	LED driver part number
LED output current	Enter value in 1mA increments, e.g. "811" for 811mA
Dimming curve	"LOG" for logarithmic (default) "LIN" for linear "SLN" for soft-linear "SQU" for square
Minimum dimming level	Leave blank for default minimum dimming level of 1.0%. Specify in 0.1% increments, e.g. "10.5" for 10.5%.
Start-up performance	Enter "CA24" for improved start-up performance to comply with ENERGY STAR Luminaires v2.0 and the latest CA Title 24 standard, effective January 2017.

Input characteristics

Nominal input voltage range AC	120 - 250V (ENEC), 120 - 277V (UL)
Absolute input voltage range AC	120 - 277V
Nominal input voltage range DC	120 - 250V
Maximum input current AC	0.65A @ 120V 0.3A @ 277V
Input frequency range	50 - 60Hz
Efficiency at full load	87.5%
Power factor at full load	> 0.95
THD at full load	< 15%
Maximum inrush current AC	<100mA ² s @ 120V <100mA ² s @ 277V
Surge protection	2kV differential mode (DM) 2kV common mode (CM)
Maximum standby power	< 0.42W

Output characteristics

Maximum LED output power	50W
Number of LED outputs	1 (UL Class 2)
Programmable LED output current range	150 - 1400mA
LED output type	Programmable in 1mA increments within specified current range
LED output current tolerance	+/- 5% at programmed LED output current
LED output voltage range	2 - 55V

Operating window

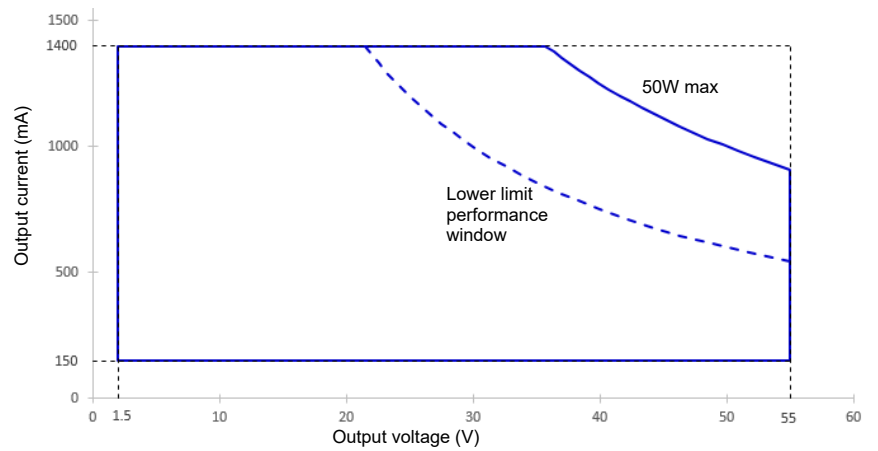

Control characteristics

Control channels	1
Control protocol	0-10V LEDcode
Dimming range	100% - 1%
Dimming curve options	Logarithmic (default) Linear Soft-Linear Square
Dimming method	Hybrid HydraDrive
0-10V current draw	0.6mA
Time delay to standby	<30s

0-10V dimming chart

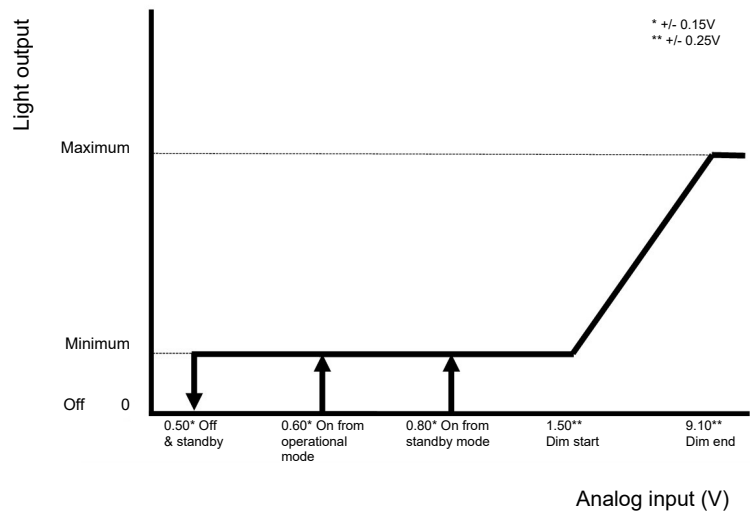

Dimming curves

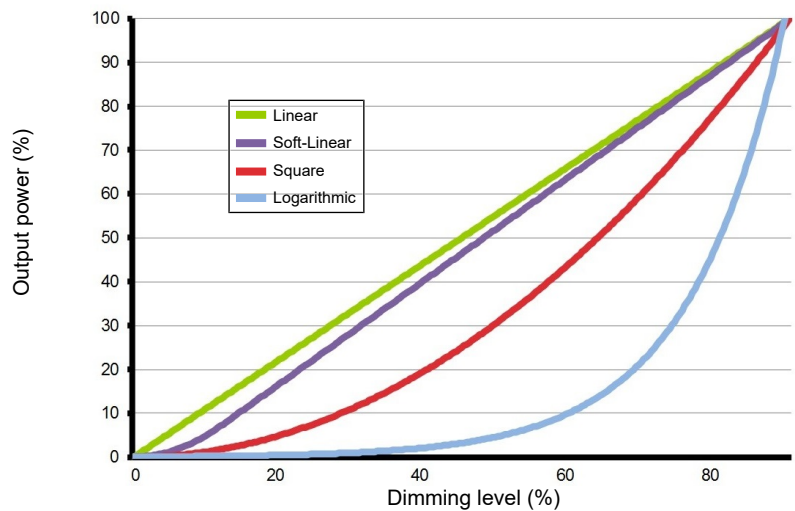

Performance

Typical efficiency vs load

Tested with a load of 16 LEDs in series, programmed for 1000mA and at 25 °C ambient temperature. The measurements below 50W were performed by dimming the light output.

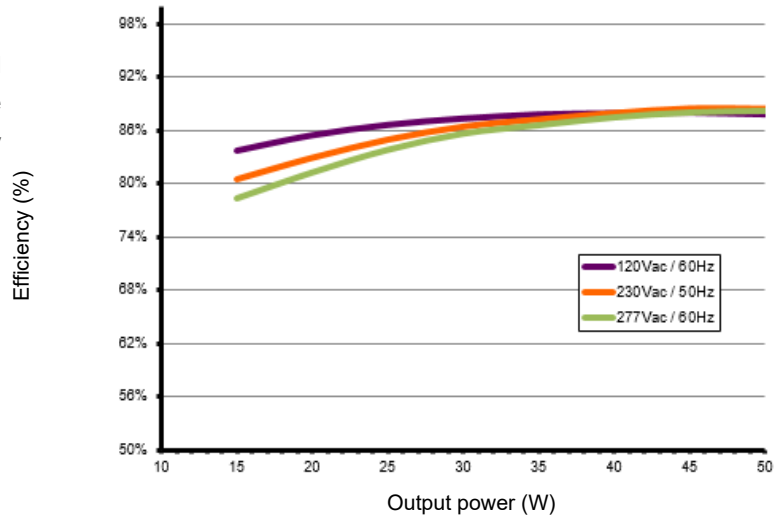

Typical power factor vs load

Tested with a load of 16 LEDs in series, programmed for 1000mA and at 25 °C ambient temperature. The measurements below 50W were performed by dimming the light output.

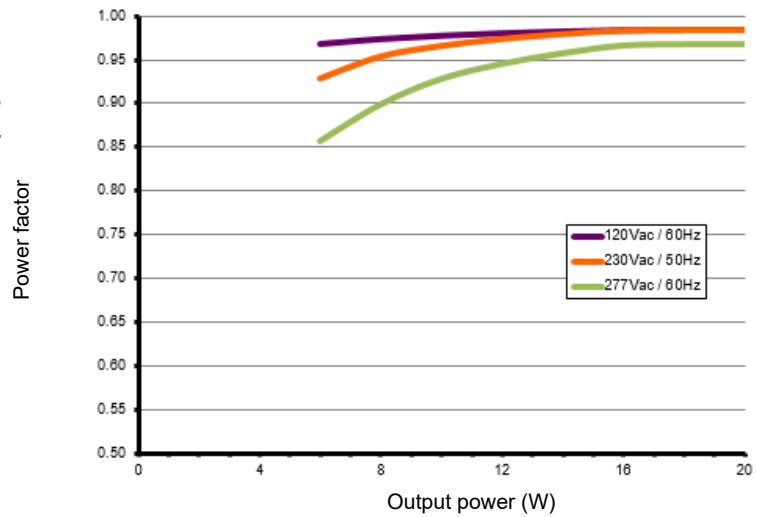

Typical THD vs load

Tested with a load of 16 LEDs in series, programmed for 1000mA and at 25 °C ambient temperature. The measurements below 50W were performed by dimming the light output.

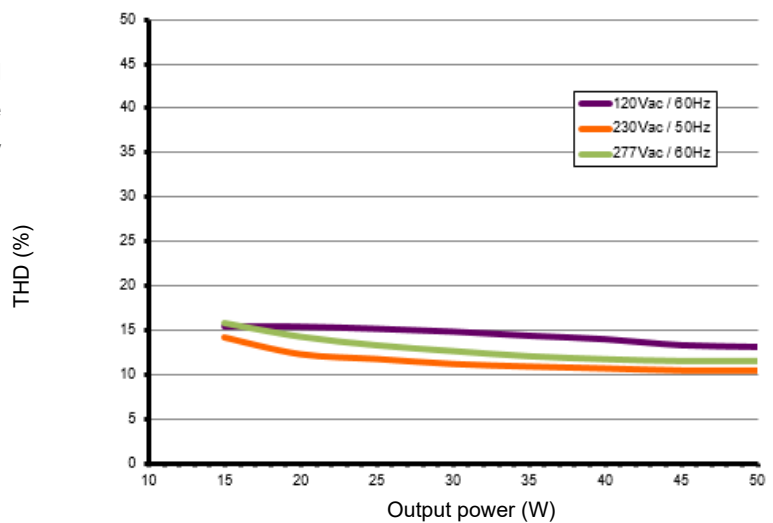

Typical flicker performance

Typical flicker percent as a function of frequency, measured across the dimming range. The results are overlaid with the low-risk (yellow) and no observable effect (green) levels as defined in IEEE P1789.

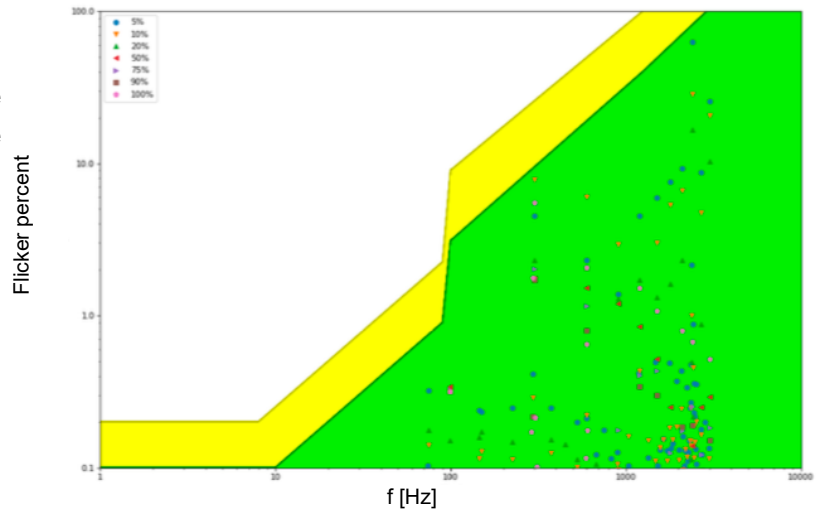

Environmental conditions

Operating ambient temperature (Ta) range -20 °C to +50 °C

Maximum operating case temperature (Tc max) 75 °C

Lifetime 50,000 hours at a maximum case temperature (Tc) of 75 °C

UL Type TL Measured Tref: 56 °C
Maximum allowed Tref: 70 °C
Measured at 1400mA

TC point location



LED driver protection

Thermal	The LED output current is decreased whenever the internal LED driver temperature exceeds factory preset temperature. The LED output current is increased again once the internal LED driver temperature drops below this internal temperature threshold. If the internal LED driver temperature continues to increase, despite a decrease in output current, the LED driver will shut down.
LED output short circuit	The LED output current is cut off whenever the LED driver detects a short-circuit. The LED driver will attempt a restart every 400ms after a short-circuit is detected.
LED output overload	The LED driver decreases the LED output current sequentially, until it reaches its maximum rated power, whenever a load that exceeds the LED driver's maximum rated power is connected to the LED output.
Reverse polarity	The LED driver will not yield any current if the polarity of the load on the LED output is reversed. This situation will not damage the LED driver but may damage the LED load.

LED protection

Thermal protection LED	An external NTC thermistor, which is placed on a PCB near the LEDs, can be connected to the driver via the LEDcode/NTC terminals. The output current to the LEDs is then decreased by 75% whenever the NTC exceeds a maximum allowable temperature, which is specified by the user in the FluxTool software. The default NTC temperature limit is set to 70 °C.
Thermistor value	47kΩ
Suitable thermistors	Leaded: Vishay, P/N 238164063473 Screw: Vishay, P/N NTCASCWE3473J

LED driver mechanical details

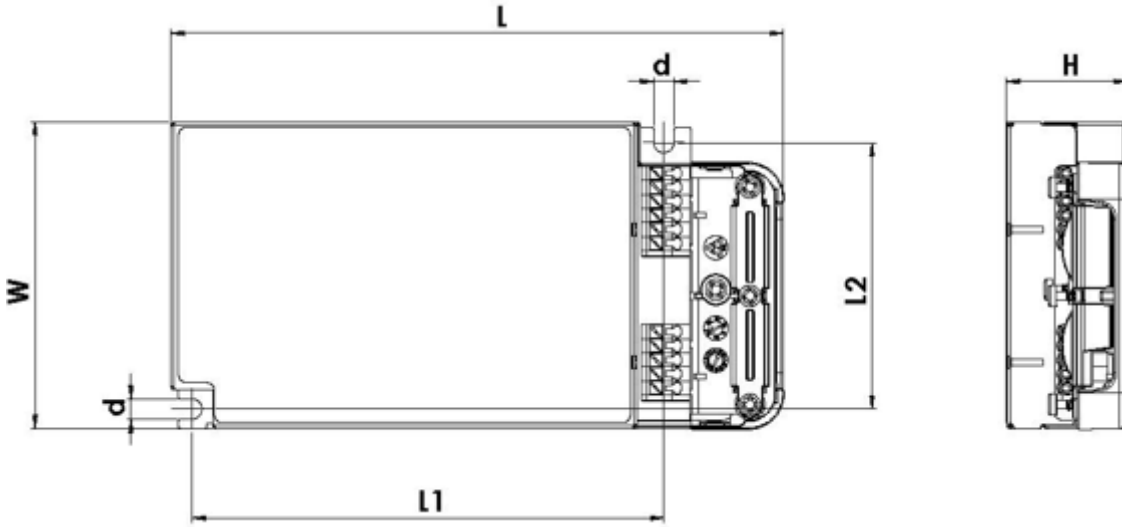

Length (L)	typical: 153.1 mm / 6.03 in maximum: 153.6 mm / 6.05 in
Width (W)	typical: 76.2 mm / 3 in maximum: 76.7 mm / 3.02 in
Height (H)	typical: 30.1 mm / 1.19 in maximum: 30.6 mm / 1.20 in
Mounting hole diameter (d)	typical: 5 mm / 0.20 in maximum: 5.2 mm / 0.20 in
Center to center mounting hole distance (L1)	typical: 118 mm / 4.65 in maximum: 118.5 mm / 4.67 in
Center to center mounting hole distance (L2)	66.2 mm / 2.61 in tolerance: 0.5 mm / 0.02 in
3D files available on product web page	IGS STEP
Weight	295 g
Mounting torque	Not to exceed 0.5Nm

Packaging

Length x Width x Height	480 x 380 x 200 mm / 18.9 x 14.96 x 7.87 in
Weight (including products)	15.0 kg
Products per box	40 pcs

Connector layout

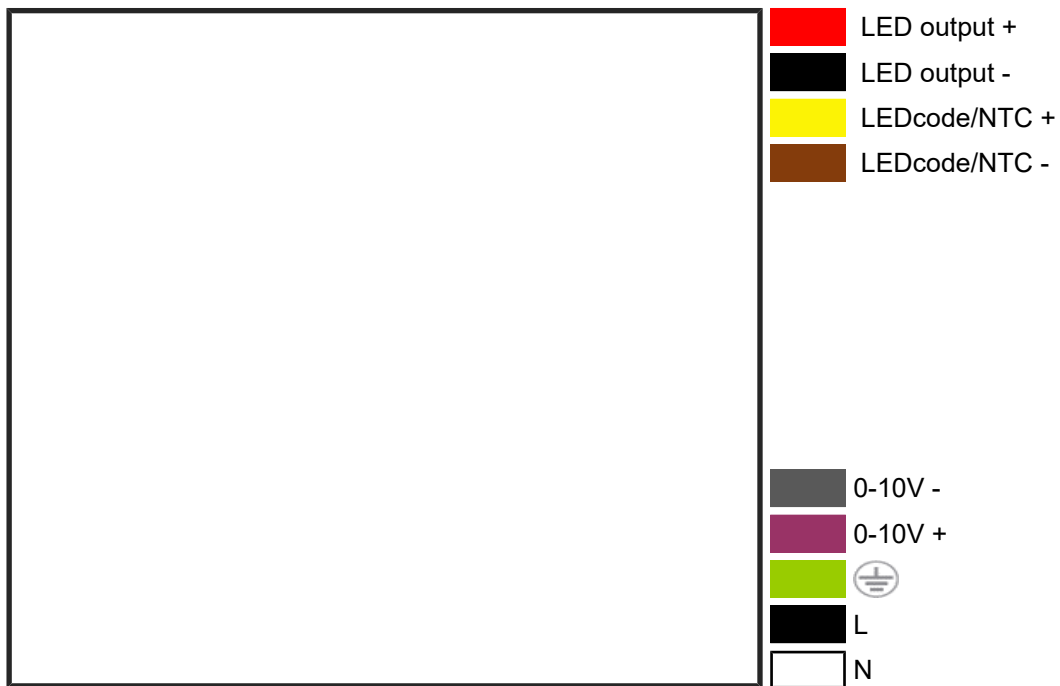

Input wiring specifications

Connector type	push-in terminals
Connector supplier and series	Wago 250 series
Wire type	solid or stranded copper
Wire core cross section	0.5 - 1.5mm / AWG 20 – 16
Wire strip length	9.0mm / 11/32"

Output wiring specifications

Connector type	push-in terminals
Connector supplier and series	Wago 250 series
Wire type	solid or stranded copper
Wire core cross section	0.5 - 1.5mm / AWG 20 – 16
Wire strip length	9.0mm / 11/32"
Maximum remote mounting distance of LED load	For independent use: 2 m / 6.5 ft For in-fixture use: AWG 20 (0.52 mm ²) - 14 m / 46 ft AWG 19 (0.65 mm ²) - 18 m / 59 ft AWG 18 (0.82 mm ²) - 22 m / 72 ft AWG 17 (1.04 mm ²) - 28 m / 92 ft AWG 16 (1.31 mm ²) - 36 m / 118 ft

Automatic circuit breakers (MCB)

Maximum loading	MCB type	B10	B13	B16	C10	C13	C16
	Number of LED drivers		14	18	22	14	18

Standards and compliance

UL, recognized component	UL 1310 UL 8750 (Class 2 output). Type TL LED driver.
ENEC safety	EN 61347-1 EN 61347-2-13 (Emergency lighting)
ENEC performance	EN 62384
Conducted emissions	EN 55015, Class B
Radiated emissions	EN 55015, Class B
Radio disturbance characteristics	EN 55022
Harmonic current emissions	EN 61000-3-2
Electromagnetic immunity	EN 61547
0-10V	IEC/EN 60929 annex E NOTE: From 0.6V to 10V eldoLED LED drivers comply with IEC/EN 60929 annex E. Below 0.6V eldoLED LED drivers comply with ABL 0-10V Design Spec v1.2 enabling standby mode. For detailed dimming characteristics see 0-10V response chart in Control Characteristics.
Surge protection	IEC 61000-4-5 level 3: 2kV DM, 2kV CM @ 2 Ohm
Surge protection	ANSI 62.41 1991 category B1: 2.5kV DM, 2.5kV CM @ 30 Ohm 0-10V input: 0.5 kV DM, 1 kV CM surge
FCC	47 CFR Part 15 class B
RCM	AS/NZS 61347.1, AS/NZS 61347.2.13
Restriction of hazardous substances	RoHS3 (Directives 2011/65/EU-2015/863/EU)

Certifications



RCM independent control gear classification

Clearance type	Description	Distance
Height clearance to building element (HCB)	Minimum distance between the top of the control gear and any building element above it	50 mm

Minimum insulation clearance (MIC)	Minimum distance between the top of the control gear and the building insulation above it	50 mm
Side clearance to building element (SCB)	Minimum distance between the side of the control gear and any building element	50 mm
Side clearance to insulation (SCI)	Minimum distance between the side of the control gear and any building insulation	50 mm

Safety



FELV control terminals marked "Risk of electric shock" are not safe to touch. Dimming connected to FELV control terminal shall be insulated for Low Voltage supply of the control gear. Any terminals connected to the FELV circuit shall be protected against accidental contact.



Risk of electrical shock. May result in serious injury or death. Disconnect power before servicing or installing.



The LED driver may only be connected and installed by a qualified electrician. All applicable regulations, legislation, and building codes must be observed. Incorrect installation of the LED driver can cause irreparable damage to the LED driver and the connected LEDs.

Pay attention when connecting the LEDs: polarity reversal results in no light output and often damages the LEDs.



LED drivers are designed and intended to operate LED loads only. Powering non-LED loads may push the LED driver outside its specified design limits and is, therefore, not covered by any warranty.



eldoLED products are designed to meet the performance specifications as outlined at certain operating conditions in the data sheet. It is the responsibility of the fixture manufacturer to test and validate the design and operation of the system under expected and potential use cases, including faults.



Please observe voltage drop over long cable lengths. Longer cable lengths increase EMI susceptibility.



Product renderings and dimensional drawings are generic for the housing type. Product label, connector type and quantity may vary.

Europe, Rest of World

eldoLED B.V.
Science Park Eindhoven 5125
5692 ED Son
The Netherlands

E: info@eldoled.com
W: www.eldoled.com

North America

eldoLED America
One Lithonia Way
Conyers, GA 30012
USA

E: info@eldoled.com
W: www.eldoled.com
