

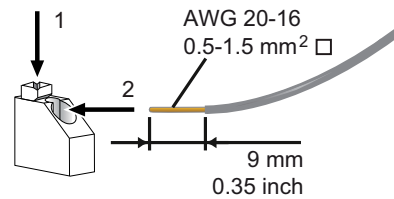

Wiring diagram SOLOdrive 565/S, 565/A

(SL0565S1, SL0565A1)

 Pay attention when connecting the LED groups:
polarity reversal results in no light output and often damages the LEDs.

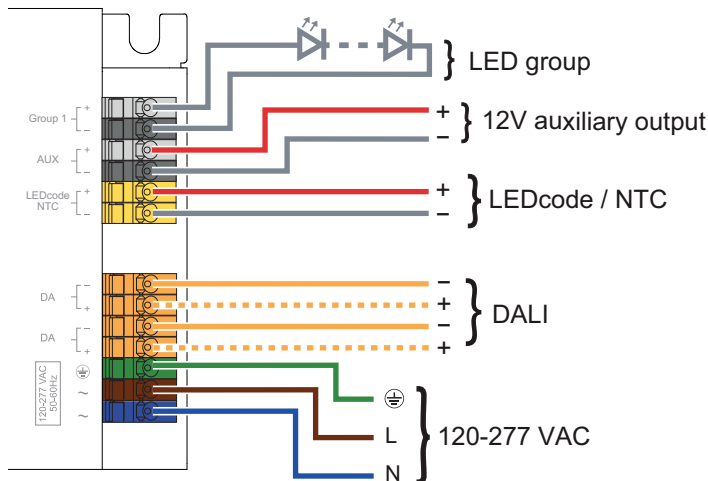

Solid or stranded copper wires only.

 **WARNING:** Risk of electrical shock. May result in serious injury or death. Disconnect power before servicing or installing.

 **CAUTION:** The device may only be connected and installed by a qualified electrician. All applicable regulations, legislation and building codes must be observed. Incorrect installation of the device can cause irreparable damage to the device and the connected LEDs.

LED group

Indicates the location of the connectors for your LED group.

LED wiring distance

Maximum wiring distance at full load (from driver to LED load):

AWG value	20	19	18	17	16
Distance (m)	14	18	22	28	36
Distance (ft)	46	59	72	92	118

 Please observe voltage drop over long cable lengths.

 Longer cable lengths increase EMI susceptibility.

12V auxiliary output

This connector can supply a 12V auxiliary fan/cooling device with up to 167mA of current. For a list of compatible 12V fans/cooling devices, please visit www.eldoled.com/compatibility

LEDcode/NTC

LEDcode allows configuration of

- Dimming curve: lin / log
- Minimum dimming level
- NTC throttle temperature
- LED drive current: from 200mA-1,050mA in 1mA steps

Programming the driver via LEDcode requires a TOOLbox pro and FluxTool software.

Connecting a 47kΩ NTC thermistor enables closed loop thermal control. The NTC throttle temperature is programmable through LEDcode.

DALI

You can use these connectors to connect the driver to a DALI network. Always combine a DA+ and DA- connector for either data input or data output.

120-277 VAC

The driver has been designed for use with universal mains voltage input of 120-277V AC, 50/60Hz, or with DC input of 120-250V (emergency lighting).